

The D1xC1 & D1xC2 combined alarm horns & strobes are classified by UL as Audible Signaling Appliances for General Signaling and Public Mode Fire Alarm use in Hazardous Locations

1) Introduction

The D1xC1 & D1xC2 range are UL Classified combined alarm horns and strobes which produce a loud warning signal in a hazardous area. Sixty-Four first stage alarm sounds can be selected by internal switches and each one can be externally changed to a second, third or fourth stage alarm sound. The alarm horn may be used for Gas applications in Class I Division 1 & 2 as well as Class I Zone 1 & 2. The D1xC1X05 variants are also ATEX / IECEx certified and can be used for gas applications in Zones 1 & 2. D1xS1 & D1xS2 alarm horns and D1xL1 & D1xL2 Loudspeakers are also available as well as variants for Explosive Dust Atmospheres.

2) Warnings

CAUTION

TO REDUCE THE RISK OF IGNITION OF HAZARDOUS ATMOSPHERES:

DISCONNECT FROM SUPPLY BEFORE OPENING.
KEEP TIGHTLY CLOSED WHEN IN OPERATION.

WARNING

FIT SEALING FITTING IN CONDUIT RUNS WITHIN 18 INCHES FROM ENCLOSURE.

DO NOT OPEN WHEN AN EXPLOSIVE ATMOSPHERE IS PRESENT

DO NOT OPEN WHEN ENERGISED

POTENTIAL ELECTROSTATIC CHARGING HAZARD - CLEAN ONLY WITH A DAMP CLOTH

ATTENTION

POUR RÉDUIRE LE RISQUE D'INFLAMMATION DES ATMOSPHÈRES DANGEREUSES:

COUPER L'ALIMENTATION AVANT OUVERTURE.
CONSERVER FERMÉ PENDANT LE FONCTIONNEMENT.

AVERTISSEMENT

CONDUITS DOIVENT ÊTRE SCELLÉS EN MOINS DE 18 POUÇES.

NE PAS OUVRIR UN PRESENCE D'ATMOSPHERE EXPLOSIVE

NE PAS OUVRIR ENERGIE

DANGER POTENTIEL CHARGE ÉLECTROSTATIQUE - NETTOYER UNIQUEMENT AVEC UN CHIFFON HUMIDE

3) Ratings and Markings

The D1xC1 and D1xC2 combined alarm horns and strobes comply with the following standards for hazardous locations:

UL 1203
CSA C22.2 NO. 30-M1986

The D1xC1 and D1xC2 combined alarm horns and strobes also comply with the following standards for signaling equipment:

UL464, UL1638
CSA C22.2 NO. 205-12

3.1 Class / Division Ratings for US & Canada

The D1xC1X05-DC024 / D1xC1X05-AC115 combined alarm horns and strobes are rated as follows:

Class I Div 1	ABCD	T5	Ta -40°C to +70°C
Class I Div 1	ABCD	T6	Ta -40°C to +55°C

The D1xC1X05-AC230 combined alarm horns and strobes are rated as follows:

Class I Div 1	ABCD	T6	Ta -40°C to +55°C
---------------	------	----	-------------------

The D1xC1X10 / D1xC2X05 / D1xC2X10 combined alarm horns and strobes are rated as follows:

Class I Div 1	ABCD	T5	Ta -40°C to +55°C
Class I Div 1	ABCD	T6	Ta -40°C to +50°C

Installation must be carried out in compliance with the National Electric Code / Canadian Electric Code

3.2 Class / Zone ratings for US & Canada

The D1xC1X05-DC024 / D1xC1X05-AC115 combined alarm horns and strobes are rated as follows:

Class I Zone 1	IIC	T5	Ta -40°C to +70°C
Class I Zone 1	IIC	T6	Ta -40°C to +55°C

The D1xC1X05-AC230 combined alarm horns and strobes are rated as follows:

Class I Zone 1	IIC	T6	Ta -40°C to +55°C
----------------	-----	----	-------------------

The D1xC1X10 / D1xC2X05 / D1xC2X10 combined alarm horns and strobes are rated as follows:

Class I Zone 1	IIC	T5	Ta -40°C to +55°C
Class I Zone 1	IIC	T6	Ta -40°C to +50°C

Installation must be carried out in compliance with the National Electric Code / Canadian Electric Code

3.3 Fire Alarm Rating

The following models are approved for use as audible signal appliances for fire alarm use – public mode and produce a sound pressure level above 75dB(A) at 10 feet:

D1xC1X05-DC024 / D1xC1X10-DC024
D1xC2X05-DC024 / D1xC2X10-DC024

For public mode fire alarm use the temporal pattern tone No. 12 as per the tone table provided in these instructions must be selected. Only units with clear lens may be used.

3.4 Ambient Temperature Range:

For D1xC1X05-DC024 / D1xC1X05-AC115
-40°C to +70°C (D1xC1X05-DC024 / D1xC1X05-AC115 only)

For D1xC1X05AC230 / D1xC1X10 / D1xC2X05 / D1xC2X10
-40°C to +55°C

3.5 Ingress Protection Ratings

The product is rated for ingress protection as follows:

IP rating per EN60529: IP66
Type rating per UL50E / NEMA250: 4 / 4X / 3R / 13

D1xC1 has been tested and found suitable for use in atmospheres containing the following chemicals in accordance with UL1203:

Acetone
Ammonium Hydroxide
Diethyl Ether
Ethyl Acetate
Ethylene Dichloride
Furfural
n-Hexane
Methyl Ethyl Ketone
Methanol
2-Nitropropane
Toluene

3.6 ATEX / IECEx certification

The D1xC1 Combined Alarm Horns comply with the following standards for hazardous locations:

EN60079-0:2018 / IEC60079-0: ed. 7.0 (2017)
EN60079-1:2014 / IEC60079-1: ed. 7.0 (2014)

The D1xC1X05DC024 Combined Alarm Horns are rated as follows:

Ex db IIC T4 Gb Ta -40°C to +75°C
Ex db IIC T5 Gb Ta -40°C to +60°C
Ex db IIC T6 Gb Ta -40°C to +45°C

The D1xC1X05AC115 Combined Alarm Horns are rated as follows:

Ex db IIC T4 Gb Ta -40°C to +75°C
Ex db IIC T5 Gb Ta -40°C to +55°C
Ex db IIC T6 Gb Ta -40°C to +40°C

The D1xC1X05AC230 Combined Alarm Horns are rated as follows:

Ex db IIC T4 Gb Ta -40°C to +75°C
Ex db IIC T5 Gb Ta -40°C to +45°C

Model No.: D1xC1

Input Voltage: DC Units 24V
AC Units 115V or 230V

Certificate No. DEMKO 19 ATEX 2141X
IECEX ULD 19.0008X

Epsilon x
Equipment Group and
Category:

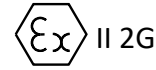

CE Marking
Notified Body No.



The units can be installed in locations with the following conditions:

Area Classification Gas:

Zone 1	Explosive gas air mixture likely to occur in normal operation.
Zone 2	Explosive gas air mixture not likely to occur in normal operation, and if it does, it will only exist for a short time.

Gas Groupings:

Group IIA	Propane
Group IIB	Ethylene
Group IIC	Hydrogen and Acetylene

Temperature Classification:

T1	450°C
T2	300°C
T3	200°C
T4	135°C
T5	100°C
T6	85°C

Equipment Category: 2G

Equipment Protection Level: Gb, Gc

Ambient Temperature Range: -40°C to +75°C

Installation must be carried out in compliance with the latest issue of the following standards:

EN60079-14 / IEC60079-14: Explosive atmospheres - Electrical installations design, selection and erection
EN60079-10-1 / IEC60079-10-1: Explosive atmospheres - Classification of areas. Explosive gas atmospheres

3.7 Electrical Ratings per UL Listing

Model No.	Nom. Voltage	Nom. rms current sounder ¹	Nom. rms current beacon ¹	Nom. rms current combined ¹	Voltage Range	Max. rms current combined ²
D1xC1X05-DC024	24Vdc	217 mA	323 mA	540 mA	20-28Vdc	604 mA @ 20Vdc
D1xC1X05-AC115	115Vac 60Hz	77 mA	130 mA	207 mA	110-120Vac 50/60Hz (110-115Vac 50Hz When used for ATEX/IECEx)	266 mA @ 120Vac 60Hz
D1xC1X05-AC230	230Vac 50Hz	53 mA	79 mA	132 mA	220-240Vac 50/60Hz	151 mA @ 240Vac 60Hz
D1xC1X10-DC024	24Vdc	217 mA	673 mA	890 mA	20-28Vdc	1112 mA @ 20Vdc
D1xC1X10-AC115	115Vac 60Hz	77 mA	247 mA	324 mA	110-120Vac 50/60Hz	431 mA @ 120Vac 60Hz
D1xC1X10-AC230	230Vac 50Hz	53 mA	121 mA	174 mA	220-240Vac 50/60Hz	229 mA @ 240Vac 60Hz
D1xC2X05-DC024	24Vdc	924 mA	323 mA	1247 mA	20-28Vdc	1477 mA @ 20Vdc
D1xC2X05-AC115	115Vac 60Hz	268 mA	130 mA	398 mA	110-120Vac 50/60Hz	446 mA @ 110Vac 60Hz
D1xC2X05-AC230	230Vac 50Hz	159 mA	79 mA	238 mA	220-240Vac 50/60Hz	255 mA @ 220Vac 60Hz
D1xC2X10-DC024	24Vdc	924 mA	673 mA	1597 mA	20-28Vdc	1984 mA @ 20Vdc
D1xC2X10-AC115	115Vac 60Hz	268 mA	247 mA	515 mA	110-120Vac 50/60Hz	604 mA @ 120Vac 60Hz
D1xC2X10-AC230	230Vac 50Hz	159 mA	121 mA	280 mA	220-240Vac 50/60Hz	330 mA @ 240Vac 60Hz

1) Nom. rms current draw at nom. voltage, worst case tone and 1Hz flash rate

2) Max. rms current draw at worst case voltage, tone and flash rate

3.8 Surge Current for Fire Alarm use per UL Listing

Part No.	Voltage	Peak Surge Current	RMS surge Current
D1xC1X05-DC024 / D1xC2X05-DC024	28Vdc	2.54 A @ 2.06 mS	1.29 A
D1xC1X10-DC024 / D1xC2X10-DC024	28Vdc	2.96 A @ 2.06 mS	1.61 A

Surge current given at worst case voltage, tone and flash rate

3.9 On-Axis Flash Rate and min. Light Output for Fire Alarm use per UL Listing

Part No.	Voltage	Flash Rate	Light output in candela-effective intensity	Lens Colour
D1xC1X05-DC024 / D1xC2X05-DC024	20Vdc	1Hz / 60 fpm	12 cd eff.	Clear
D1xC1X10-DC024 / D1xC2X10-DC024	20Vdc	1Hz / 60 fpm	20 cd eff.	Clear

4) Installation

4.1 Safe Installation Requirements

The product must only be installed by suitably qualified personnel in accordance with the latest issues of the relevant standards.

The installation of the units must also be in accordance with the NEC / CEC and any local regulations and should only be carried out by a competent electrical engineer who has the necessary training.

If temperature exceeds 70°C at entry or 80°C at branching point use suitable rated cable and cable glands:

	Max. ambient temperature	70°C	75°C
Req. Cable / Cable Gland Rating:	D1xC1X05DC024, D1xC1X05AC115	-	85°C
	D1xC1X05AC230	85°C	90°C

4.2 Specific Conditions of Use

To maintain the ingress protection rating and mode of protection, the cable entries must be fitted with suitably rated cable entry and/or blanking devices during installation. If conduit is used for installation, seal conduit within 18 inches from the enclosure.

If entries are fitted with adaptors they must be suitably rated for the application. Fitting of blanking elements into adaptors is not permitted.

If a high IP (Ingress Protection) rating is required then a suitable sealing washer or O-ring must be fitted under any cable gland or blanking device with metric threads.

Only the explosionproof cover is to be used for access to the enclosure for installation, service and maintenance.

Connections are to be made into the terminal blocks using solid or stranded wire, sizes 0.5-2.5mm² / AWG 20-14. Wire insulation needs to be stripped 6-7mm. Wires may be fitted securely with crimped ferrules. Terminal screws need to be tightened down with a tightening torque of 0.4 Nm / 3.5 Lb-in.

Earthing connections should be made to the Internal Earth terminal in the explosionproof chamber or the external earth stud.

Check that the 'O' ring seal is in place before replacing the explosionproof cover.

4.3 Mounting

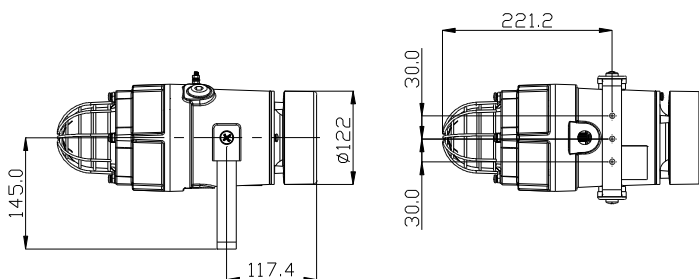

Fig. 1 Fixing locations.

The D1x Alarm Horn may be secured to any flat surface using the three 7mm fixing holes. The enclosure provides IP66

protection and is suitable for installation in exterior locations providing the cable entry is sealed.

4.4. Installation procedure

- Secure the D1x alarm horn to a flat surface via the three 7mm fixing holes in the mounting bracket.
- Remove the explosionproof cover of the alarm horn by unscrewing it, taking care not to damage the explosionproof threads in the process (Refer to section 6).
- Fit an M20/NPT suitably rated cable gland or conduit entry into the hole in the enclosure and connect the field wiring to the appropriate alarm horn terminals as shown in fig. 6 (AC) or fig 8. (DC). The power supply terminals are duplicated so that units may be connected in parallel. An end of line monitoring resistor may be fitted to DC units only (see section 14). If the second and third M20/NPT entries are not used, suitably rated stopping plugs must always be fitted.
- Replace the explosionproof cover of the loudspeaker, taking care not to damage the explosionproof threads. Tighten fully.

4.5 Hornless Variants

The D1x Sounder is also available as a variant with no horn fitted in the factory. The Horn threaded nose portion has a fitment thread of 1-3/8" – 18 UNF (to BS1580 or ANSI B1.1). The customer is responsible for sourcing and correctly fitting a suitable horn that meets all of the relevant safety requirements.

5) Access to Explosionproof Enclosure

In order to connect the electrical supply cables to the alarm horn it is necessary to remove the explosionproof cover to gain access to the explosionproof chamber. This can be achieved by unscrewing the explosionproof cover, taking extreme care not to damage the explosionproof threads in the process.

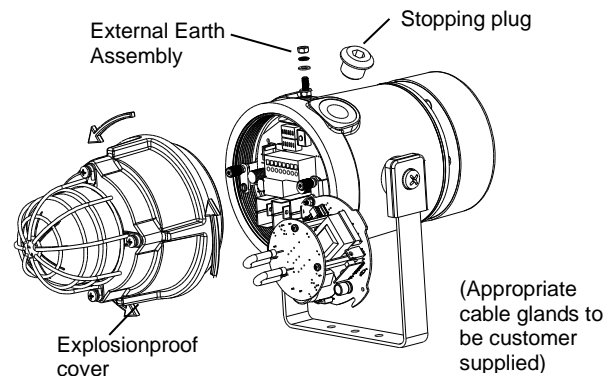
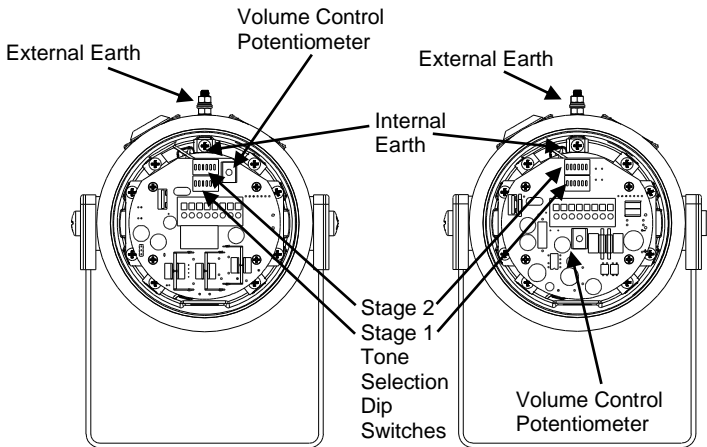

Fig. 2 Accessing the Explosionproof Enclosure.

On completion of the cable wiring installation the explosionproof threads should be inspected to ensure that they are clean and that they have not been damaged during installation. Also check that the 'O' ring seal is in place, on the thread diameter in contact with the flat face of the explosionproof cover. When replacing the explosionproof cover ensure that it is tightened fully.

6) Volume Control

The output level of the D1x alarm horn can be set by adjusting the volume control potentiometer (see Fig 3). For maximum output, set the potentiometer fully clockwise.



D1x2AC / D1x2DC / D1x1DC / D1x1AC

Fig. 3 Location of field controls

7) Tone Selection

The D1x1 & D1x2 units have 64 different tones that can be selected independently for the first and second stage alarms. The tones are selected by operation of the tone setting DIP switches 1 & 2 (see Fig. 3) on the PCB. The alarm horns can also be switched to sound the third and fourth stage alarm tones. The tone table (Table 1) shows the switch positions for the 64 tones on first and second stages and which tones are available for the third and fourth stages dependent on the Stage 1 DIP switch setting.

8) Stage Switching Polarity (DC Units Only)

The D1x2 and D1x1 DC alarm horns have the facility to use either +ve or -ve switching to change the tone to the second, third and fourth stages. For -ve switching connect the two headers on the pcb to the left-hand (marked -ve) and centre pins. For +ve switching connect the headers to the right hand (marked +ve) and the centre pins. (Refer to Fig. 4)

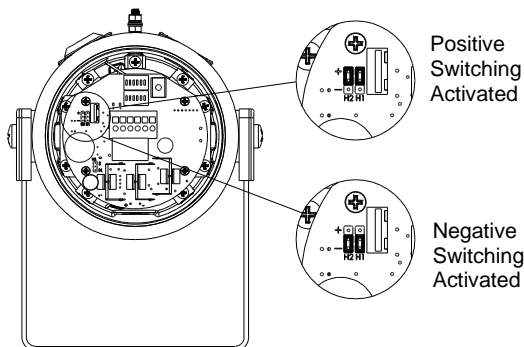

Fig. 4 Stage Switching Polarity

9) AC Wiring

10.1 Wiring Diagrams

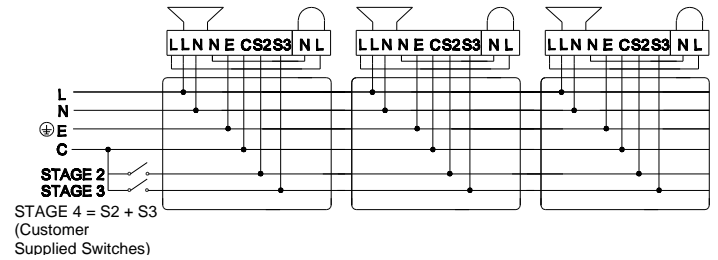

Fig 5a. D1x2 AC Simplified Block Diagram

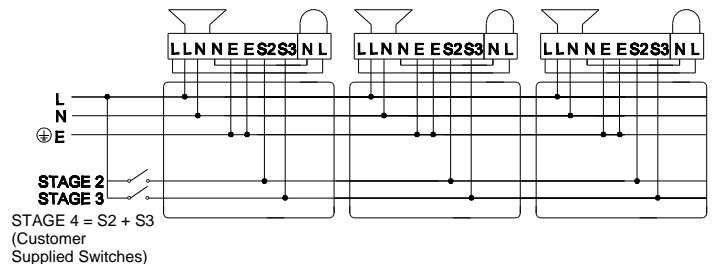

Fig 5b. D1x1 AC Simplified Block Diagram

10.2 Units First Stage Tones

Stage one (S1) operation: Simply connect the supply voltage to the L and N supply terminals, (see fig. 6).

10.3 AC Units Second, Third and Fourth Stage Tone Selection

To select the second, third and fourth stage tones on the D1x AC alarm horns.

Stage two (S2) operation : Power L and N, link the common (C) and S2 terminal.

Stage three (S3) operation : Power L and N, link the common (C) and S3 terminals.

Stage four (S4) operation : Power L and N, link the common (C) and both the S2 and S3 terminals.

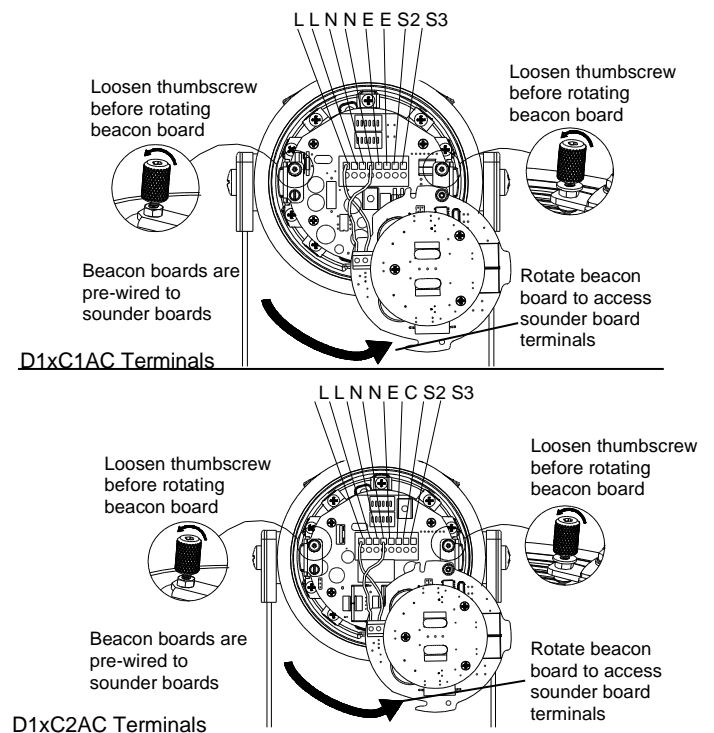

Fig. 6 AC Terminals

10) DC Wiring

11.1 Wiring Diagrams

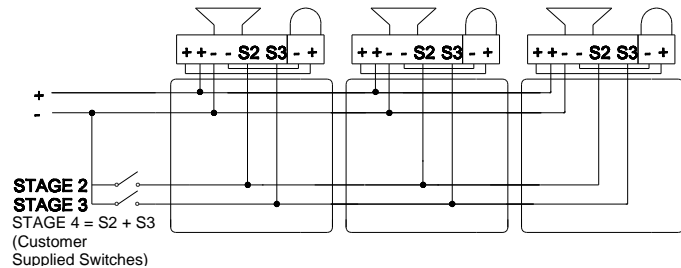

Fig. 7a DC Simplified Block Diagram (negative switching)

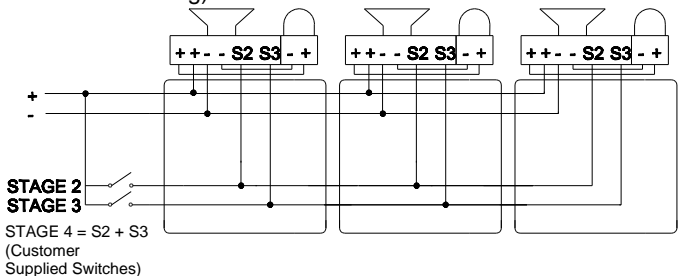

Fig. 7b DC Simplified Block Diagram (positive switching)

11.2 Units First Stage Tones

Stage one (S1) operation: Simply connect the supply voltage to the + and - supply terminals, (see fig. 8).

11.3 DC Units Second, Third and Fourth Stage Tone Selection

For units set up for -ve switching (default setting):

Stage two (S2) operation: Power +ve and -ve, link a -ve supply line to the S2 terminal. Dip switch 2 alters stage 2 tone.

Stage three (S3) operation: Power +ve and -ve, link a -ve supply line to the S3 terminal. Dip switch 1 alters stage 3 tone.

Stage four (S4) operation: Power +ve and -ve, link a -ve supply line to both the S2 & S3 terminals. Dip switch 1 alters stage 4 tone.

For units set up for +ve switching (refer to 9.1):

Stage two (S2) operation: Power +ve and -ve, link a +ve supply line to the S2 terminal. Dip switch 2 alters stage 2 tone.

Stage three (S3) operation: Power +ve and -ve, link a +ve supply line to the S3 terminal. Dip switch 1 alters stage 3 tone.

Stage four (S4) operation: Power +ve and -ve, link a +ve supply line to both the S2 & S3 terminals. Dip switch 1 alters stage 4 tone.

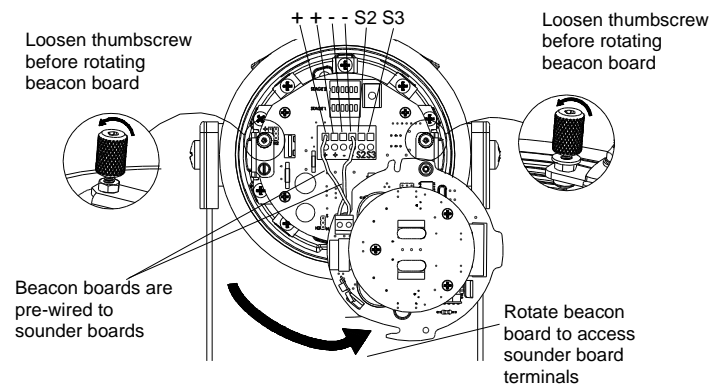

Fig. 8 DC Terminals

11) Earthing

The unit has both a primary internal and secondary external earth fixing point.

Internal earth connections should be made to the internal Earth terminal (see Fig. 3 and 4). It should be fitted to the internal earth point using a ring crimp terminal to secure the earth conductor.

In addition, external earth connections can be made to the M5 earth stud (see Fig. 2), using a ring crimp terminal to secure the earth conductor to the earth stud. The external earth crimp ring should be located between the two M5 plain washers provided and securely locked down with the M5 spring washer and M5 nut.

The earth conductor should be at least equal in size and rating to the incoming power conductors but at least a minimum of 0.82mm² / 18AWG in size.

12) Flash Rate Settings

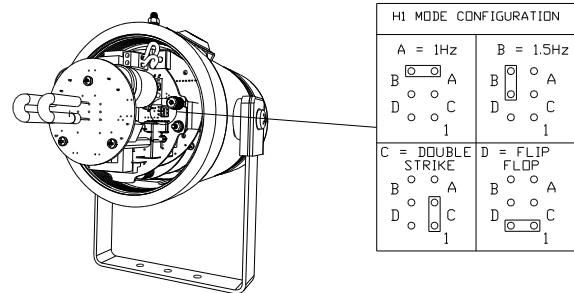
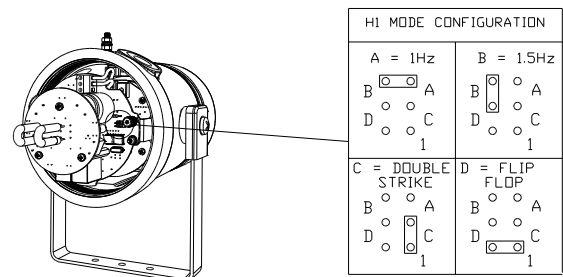

Fig. 9 DC Flash Settings



(Flip-Flop Mode not available on D1xC1X05 / D1xC2X05)

Fig. 10 AC Flash Settings

13) End Of Line Monitoring (DC Units Only)

On D1xC1DC & D1xC2DC units, dc reverse line monitoring can be used if required. All DC alarm horns have a blocking diode fitted in their supply input lines. An end of line monitoring diode or an end of line monitoring resistor can be connected across the +ve and -ve terminals. If an end of line resistor is used it must have a minimum resistance value of 3k3 ohms and a minimum power rating of 0.5 watts or a minimum resistance value of 500 ohms and a min. power rating of 2 watts.

The resistor must be connected directly across the +ve and -ve terminals as shown in the following drawing. The resistor leads should be kept as short as possible.

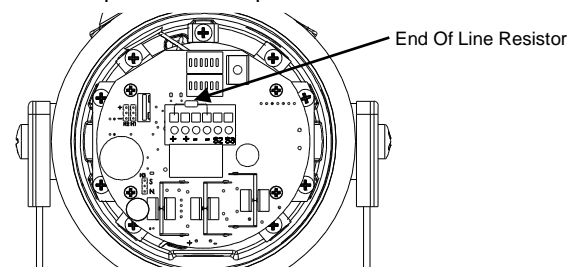
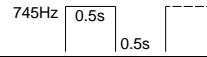
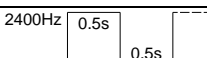
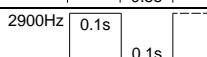
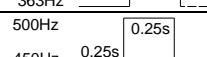
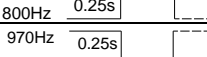
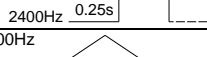
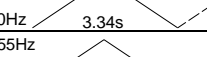
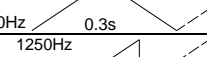
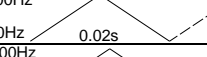
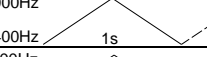
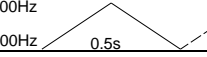
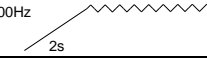

Fig. 11 End Of Line Resistor

Tone Selection – To select the required first stage tone set the tone Set DIP switch 1 (6 way DIP see Fig 3) to the required tone setting shown in the table below. The table also shows the second stage tone can be set independently with the Stage 2 DIP switch to select the required tone. The 3rd and 4th stage tones are available if more than two tone output stages are required, they are set/linked via the first stage tone selection.

Stage 1 Set DIP Switch 1 Tone No	Tone Description	Tone Visual	Stage 1 & 2 DIP Switch Settings 1 2 3 4 5 6	Stage 2 Set DIP Switch 2 Tone (S2)	Stage 3 Set DIP Switch 1 Tone (S3)	Stage 4 Set DIP Switch 1 Tone (S2 + S3)
1	1000Hz PFEER Toxic Gas	1000Hz ———	0 0 0 0 0 0	1	2	44
2	1200/500Hz @ 1Hz DIN / PFEER P.T.A.P.		1 0 0 0 0 0	2	3	44
3	1000Hz @ 0.5Hz(1s on, 1s off) PFEER Gen. Alarm		0 1 0 0 0 0	3	2	44
4	1.4KHz-1.6KHz 1s, 1.6KHz-1.4KHz 0.5s NF C 48-265		1 1 0 0 0 0	4	24	1
5	544Hz(100mS)/440Hz (400mS) NF S 32-001		0 0 1 0 0 0	5	19	1
6	1500/500Hz - (0.5s on, 0.5s off) x3 + 1s gap AS4428		1 0 1 0 0 0	6	44	1
7	500-1500Hz Sweeping 2 sec on 1 sec off AS4428		0 1 1 0 0 0	7	44	1
8	500/1200Hz @ 0.26Hz(3.3s on, 0.5s off) Netherlands - NEN 2575		1 1 1 0 0 0	8	24	35
9	1000Hz (1s on, 1s off)x7 + (7s on, 1s off) IMO Code 1a		0 0 0 1 0 0	9	34	1
10	1000Hz (1s on, 1s off)x7 + (7s on, 1s off) IMO Code 1a		1 0 0 1 0 0	10	34	1
11	420Hz(0.5s on, 0.5s off)x3 + 1s gap ISO 8201 Temporal Pattern		0 1 0 1 0 0	11	1	8
12	1000Hz(0.5s on, 0.5s off)x3 + 1s gap ISO 8201 Temporal Pattern		1 1 0 1 0 0	12	1	8
13	422/775Hz - (0.85 on, 0.5 off) x3 + 1s gap NFPA - Temporal Coded		0 0 1 1 0 0	13	1	8
14	1000/2000Hz @ 1Hz Singapore		1 0 1 1 0 0	14	3	35
15	300Hz Continuous	300Hz ———	0 1 1 1 0 0	15	24	35
16	440Hz Continuous	440Hz ———	1 1 1 1 0 0	16	24	35
17	470Hz Continuous	470Hz ———	0 0 0 0 1 0	17	24	35
18	500Hz Continuous IMO code 2 (Low)	500Hz ———	1 0 0 0 1 0	18	24	35
19	554Hz Continuous	554Hz ———	0 1 0 0 1 0	19	24	35
20	660Hz Continuous	660Hz ———	1 1 0 0 1 0	20	24	35
21	800Hz IMO code 2 (High)	800Hz ———	0 0 1 0 1 0	21	24	35
22	1200Hz Continuous	1200Hz ———	1 0 1 0 1 0	22	24	35
23	2000Hz Continuous	2000Hz ———	0 1 1 0 1 0	23	3	35
24	2400Hz Continuous	2400Hz ———	1 1 1 0 1 0	24	20	35
25	440 @ 0.83Hz (50 cycles/minute) Intermittent		0 0 0 1 1 0	25	44	8
26	470 @ 0.9Hz - 1.1s Intermittent		1 0 0 1 1 0	26	44	8
27	470Hz @ 5Hz - (5 cycles/second) Intermittent		0 1 0 1 1 0	27	44	8
28	544Hz @ 1.14Hz - 0.875s Intermittent		1 1 0 1 1 0	28	24	8
29	655Hz @ 0.875Hz Intermittent		0 0 1 1 1 0	29	44	8
30	660Hz @ 0.28Hz - 1.8sec on, 1.8sec off Intermittent		1 0 1 1 1 0	30	24	8
31	660Hz @ 3.34Hz - 150mS on, 150mS off Intermittent		0 1 1 1 1 0	31	24	8

32	745Hz @ 1Hz Intermittent		1 1 1 1 1 0	32	24	8
33	800Hz - 0.25sec on, 1 sec off Intermittent		0 0 0 0 0 1	33	24	8
34	800Hz @ 2Hz IMO code 3.a (High) Intermittent		1 0 0 0 0 1	34	24	8
35	1000Hz @ 1Hz Intermittent		0 1 0 0 0 1	35	24	8
36	2400Hz @ 1Hz Intermittent		1 1 0 0 0 1	36	24	8
37	2900Hz @ 5Hz Intermittent		0 0 1 0 0 1	37	24	8
38	363/518Hz @ 1Hz Alternating		1 0 1 0 0 1	38	8	19
39	450/500Hz @ 2Hz Alternating		0 1 1 0 0 1	39	8	19
40	554/440Hz @ 1Hz Alternating		1 1 1 0 0 1	40	24	19
41	554/440Hz @ 0.625Hz Alternating		0 0 0 1 0 1	41	8	19
42	561/760Hz @ 0.83Hz (50 cycles/minute) Alternating		1 0 0 1 0 1	42	8	19
43	780/600Hz @ 0.96Hz Alternating		0 1 0 1 0 1	43	8	19
44	800/1000Hz @ 2Hz Alternating		1 1 0 1 0 1	44	24	19
45	970/800Hz @ 2Hz Alternating		0 0 1 1 0 1	45	8	19
46	800/1000Hz @ 0.875Hz Alternating		1 0 1 1 0 1	46	24	19
47	2400/2900Hz @ 2Hz Alternating		0 1 1 1 0 1	47	24	19
48	500/1200Hz @ 0.3Hz Sweeping		1 1 1 1 0 1	48	24	12
49	560/1055Hz @ 0.18Hz Sweeping		0 0 0 0 1 1	49	24	12
50	560/1055Hz @ 3.3Hz Sweeping		1 0 0 0 1 1	50	24	12
51	600/1250Hz @ 0.125Hz Sweeping		0 1 0 0 1 1	51	24	12
52	660/1200Hz @ 1Hz Sweeping		1 1 0 0 1 1	52	24	12
53	800/1000Hz @ 1Hz Sweeping		0 0 1 0 1 1	53	24	12
54	800/1000Hz @ 7Hz Sweeping		1 0 1 0 1 1	54	24	12
55	800/1000Hz @ 50Hz Sweeping		0 1 1 0 1 1	55	24	12
56	2400/2900Hz @ 7Hz Sweeping		1 1 1 0 1 1	56	24	12
57	2400/2900Hz @ 1Hz Sweeping		0 0 0 1 1 1	57	24	12
58	2400/2900Hz @ 50Hz Sweeping		1 0 0 1 1 1	58	24	12
59	2500/3000Hz @ 2Hz Sweeping		0 1 0 1 1 1	59	24	12
60	2500/3000Hz @ 7.7Hz Sweeping		1 1 0 1 1 1	60	24	12
61	800Hz Motor Siren		0 0 1 1 1 1	61	24	12
62	1200Hz Motor Siren		1 0 1 1 1 1	62	24	12
63	2400Hz Motor Siren		0 1 1 1 1 1	63	24	12
64	Simulated Bell		1 1 1 1 1 1	64	21	12